

**ANTI-VIBRATION
MOUNT KITS**

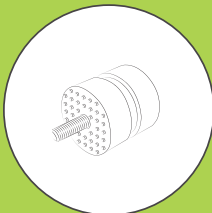

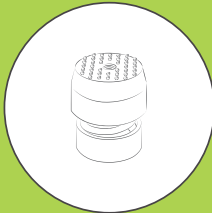

READ CAREFULLY

All the products featured in this brochure are recommended for installations in areas not subject to ***STRONG GUSTS OF WIND*** and should not to be regarded as seismic anchorages.

In the cases listed below, we recommend that the units be installed with ad hoc products and containment systems:

- *Machine with a high center of gravity (TOP HEAVY).*
- *Machine with a height greater than 80 cm from floor level.*
- *Installation in areas exposed to strong gusts of wind.*

For special requests or clarifications, you can send an email to sales@solecosrl.com.





ANTI-VIBRATION MOUNT KITS

Suitable for domestic units, small pumps, generators, air conditioning units or heat pumps.

The colors identify the weight of the machine and inside each package you can find a kit of screws, washers and nuts and instructions for installation.

All *anti-vibration feet* are made of THERMOPLASTIC ELASTOMER which unlike natural rubber, has a high resistance to tearing, atmospheric aging, ozone, detergents, UV rays and also resists to temperatures from -45°C to $+110^{\circ}\text{C}$.

Discover our modular COUNTER DISPLAY on page 25.

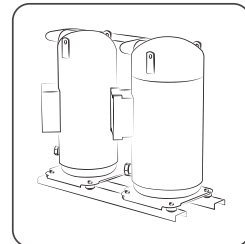
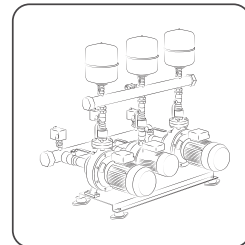
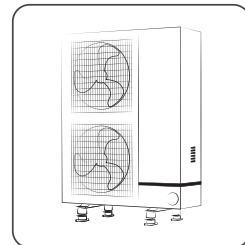
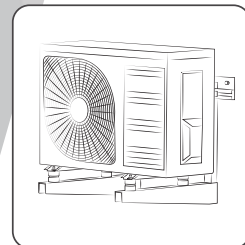

HOW TO CHOOSE THE SUITABLE SERIES?

KIT SERIES	WEIGHT OF THE MACHINE TO ISOLATE						TYPE OF FIXING				SPRING INSIDE	INFO ON PAGE
	max. 120 Kgs	max. 170 Kgs	max. 450 Kgs	max. 600 Kgs	max. 1000 Kgs	max. 1600 Kgs	ON WALL BRACKET	ON GROUND BASE	GROUND ANCHORING	ON THE GROUND		
MNaZc series	●						●	●			●	3
PMNaZc series	●								●		●	5
MNaZb series		●					●	●			●	7
PMNaZb series		●							●		●	9
MNT series			●							●		11
NOCE4040 series			●				●	●				13
PNOCE4040 series			●						●			15
SEG9525 series				●					●	●		17
NOCE6050 series					●		●	●				19
PNOCE6050 series					●				●	●		21
MCF series						●				●		23

This chart shows the maximum weights achieved by the series.

To view the machine weights covered by the different kits within each series, view the pages indicated in the chart.

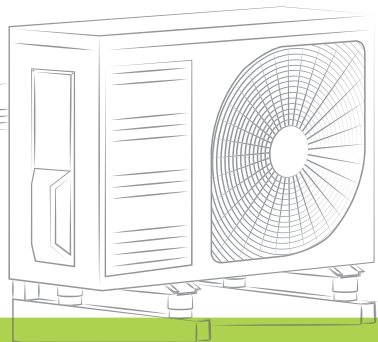

SPRING INSIDE

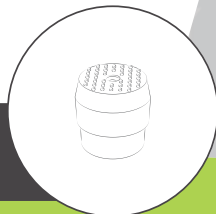

MNaZc series

WIND RESISTANT

PATENTED telescopic anti-vibration spring mount that allows, once loaded, to increase the axial resistance to thrusts due to the action of the wind.

Suitable to isolate air conditioning units, pumps or fans.

KIT CONTENTS

- 4 MNaZc feet
- 8 M8 washers
- 8 M8 TE screws
- Installation guide



MNaZc

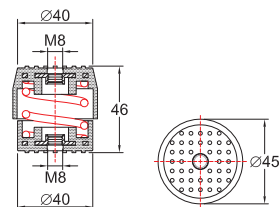

max.
55 Kgs

max.
80 Kgs

max.
120 Kgs



CB1MNaV/00000



CB1MNaG/00000



CB1MNaM/00000

**ON WALL BRACKET
ON GROUND BASE**



INSTALLATION INSTRUCTIONS

1. Place the feet in correspondence of the anchoring holes considering that the stiffer feet must be installed on the opposite side of the grill, as indicated in the instructions contained inside the blister.
2. Fix the feet to the machine and to the bracket using screws and washers.
3. Anti-vibration feet installed correctly.

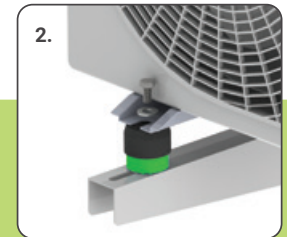
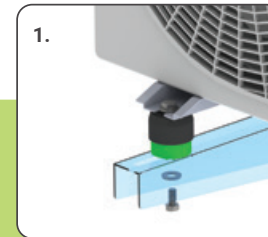

SPRING INSIDE

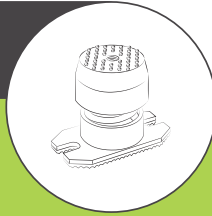

PMNaZc series

WIND RESISTANT

PATENTED telescopic anti-vibration spring mount that allows, once loaded, to increase the axial resistance to thrusts due to the action of the wind.

Steel base plate with 2 cavities for anchoring the mount to the ground.

The surface of the plates has slip-proof, flexible embossing which allow the charged anti-vibration feet to stand by friction and at the same time reduce the transmission of noise.



KIT CONTENTS

- 4 PMNaZc feet
- 4 M8 washers
- 8 M8 TE screws
- Allen key and Installation guide

PMNaZc

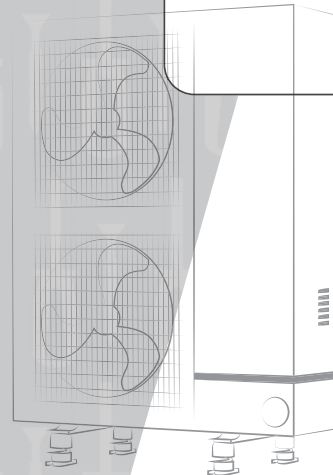
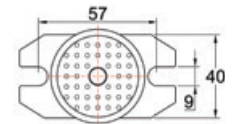
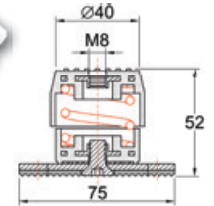

max.
55 Kgs



CB1PMNaV/00000

max.
80 Kgs



CB1PMNaG/00000

max.
120 Kgs



CB1PMNaM/00000

GROUND ANCHORING



INSTALLATION INSTRUCTIONS

1. Screw the plates to the colored bases of the anti-vibration feet with the screws and the allen wrench supplied.
2. Place the feet in correspondence of the anchoring holes considering that the stiffer feet must be installed on the opposite side of the grill, as indicated in the instructions contained inside the blister.
3. Fix the feet to the machine and to the bracket using screws and washers.

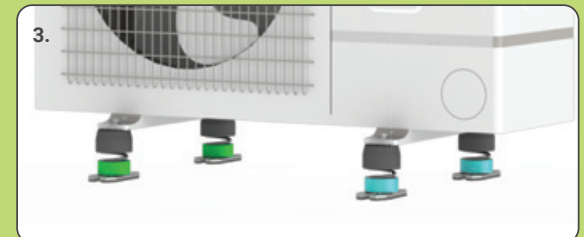
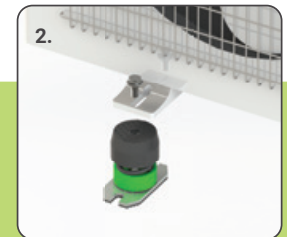

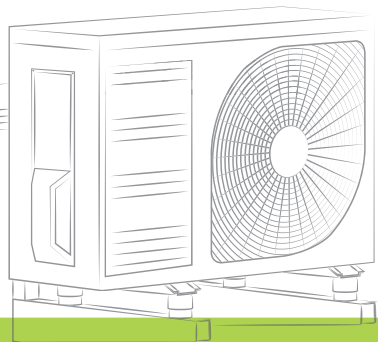

SPRING INSIDE

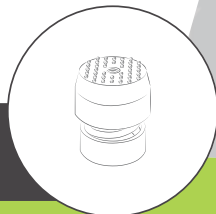

MNaZb series

WIND RESISTANT

PATENTED telescopic anti-vibration spring mount that allows, once loaded, to increase the axial resistance to thrusts due to the action of the wind.

Suitable to isolate air conditioning units, pumps or fans.

KIT CONTENTS

- 4 MNaZb feet
- 8 M8 washers
- 8 M8 TE screws
- Installation guide



MNaZb

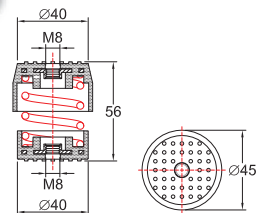

max.
90 Kgs

max.
120 Kgs

max.
170 Kgs



CB1MNaZbV/00000



CB1MNaZbG/00000



CB1MNaZbM/00000

**ON WALL BRACKET
ON GROUND BASE**



INSTALLATION INSTRUCTIONS

1. Place the feet in correspondence of the anchoring holes considering that the stiffer feet must be installed on the opposite side of the grill, as indicated in the instructions contained inside the blister.
2. Fix the feet to the machine and to the bracket using screws and washers.
3. Anti-vibration feet installed correctly.

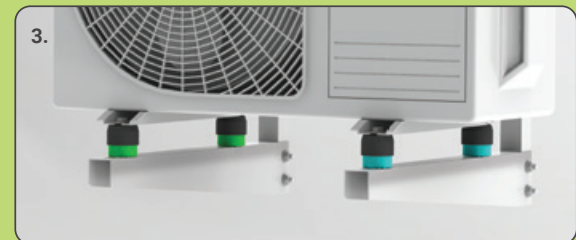
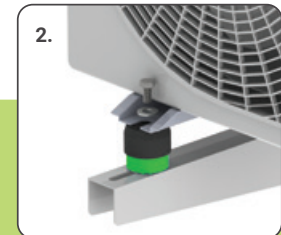
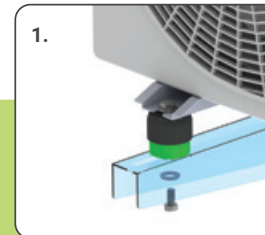

SPRING INSIDE

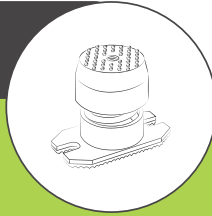

PMNaZb series

WIND RESISTANT

PATENTED telescopic anti-vibration spring mount that allows, once loaded, to increase the axial resistance to thrusts due to the action of the wind.

Steel base plate with 2 cavities for anchoring the mount to the ground.

The surface of the plates has slip-proof, flexible embossing which allow the charged anti-vibration feet to stand by friction and at the same time reduce the transmission of noise.



KIT CONTENTS

- 4 PMNaZb feet
- 4 M8 washers
- 8 M8 TE screws
- Allen key and Installation guide

PMNaZb

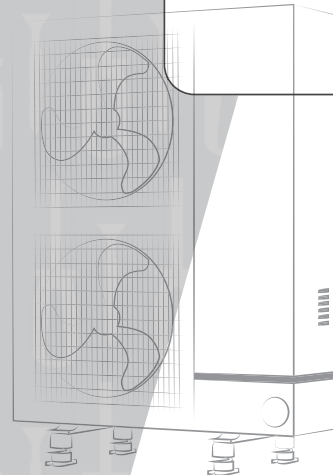
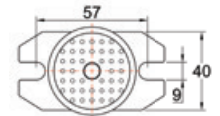
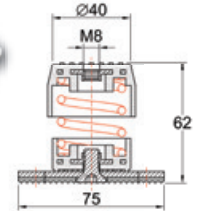

max.
90 Kgs



CB1PMNaZbV/00000

max.
120 Kgs



CB1PMNaZbG/00000

max.
170 Kgs



CB1PMNaZbM/00000

GROUND ANCHORING



INSTALLATION INSTRUCTIONS

1. Screw the plates to the colored bases of the anti-vibration feet with the screws and the allen wrench supplied.
2. Place the feet in correspondence of the anchoring holes considering that the stiffer feet must be installed on the opposite side of the grill, as indicated in the instructions contained inside the blister.
3. Fix the feet to the machine and to the bracket using screws and washers.

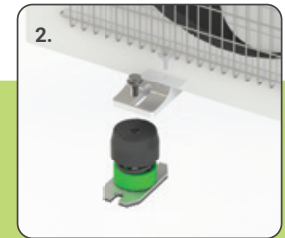
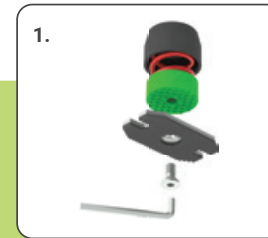

MNT series

ELASTOMERIC DAMPER

Damper in THERMOPLASTIC ELASTOMER which has a high resistance to tearing, atmospheric aging, ozone, detergents, UV rays and also resists to temperatures from -45°C to +110°C.

The surface of the plate and the base has slip-proof, flexible embossing which allow the charged anti-vibration feet to stand by friction and at the same time reduce the transmission of noise.

KIT CONTENTS

- 4 MNT feet
- 4 M8 nuts (available also in M10)
- 4 M8 washers (available also in M10)
- Installation guide

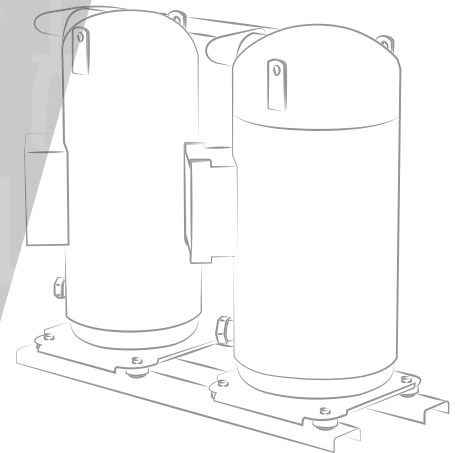
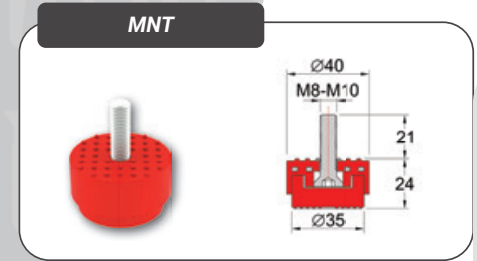
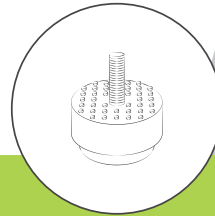

max.
150 Kgs



CBMNTM8V2040L

max.
300 Kgs



CBMNTM8V2040W

max.
450 Kgs



CBMNTM8V2040M

**ON THE
GROUND**

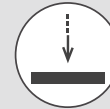

INSTALLATION INSTRUCTIONS

1. Place the feet in correspondence of the anchoring holes.
2. Fix the feet to the machine using nuts and washers.
3. Anti-vibration feet installed correctly.

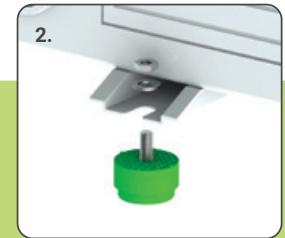
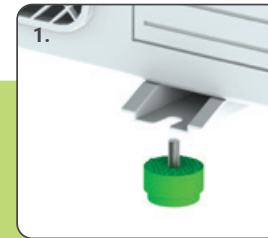

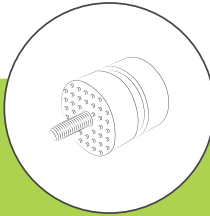

NOCE4040 series

DAMPER WITH CONTROLLED DEFLECTION

PATENTED elastomeric NOCE series damper, designed with an elastic element defined as a connector which, when used between two containers, creates the condition to obtain anti-vibration devices with controlled deflection. This design prevents the vibration damper's deformation under load while insuring the perfect machine's insulation.



AVAILABLE VERSIONS

Available in the following versions: nut-nut (NOCE4040DD), screw-nut (NOCE4040VD) or screw-screw (NOCE4040VV) depending on the anchoring needs.

KIT CONTENTS

- 4 NOCE4040 feet
- M8 nuts
- M8 washers
- M8 TE screws
- Installation guide

NOCE4040DD

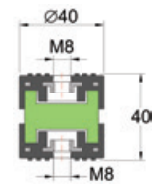

SCREWS: 8 M8 washers and 8 M8 TE screws

NOCE4040VD

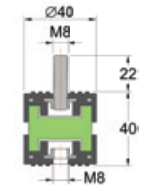

SCREWS: 4 M8 nuts, 8 M8 washers and 4 M8 TE screws

NOCE4040VV

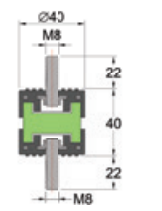

SCREWS: 4 M8 nuts and 8 M8 washers

max.
100 Kgs



CBNOCEVD4040L

max.
200 Kgs



CBNOCEVD4040W

max.
350 Kgs



CBNOCEVD4040M

max.
450 Kgs



CBNOCEVD4040H

ON WALL BRACKET
ON GROUND BASE



INSTALLATION INSTRUCTIONS

1. Place the feet in correspondence of the anchoring holes.
2. Fix the feet to the machine and to the bracket using screws, nuts and washers depending on your necessity.
3. Anti-vibration feet installed correctly.

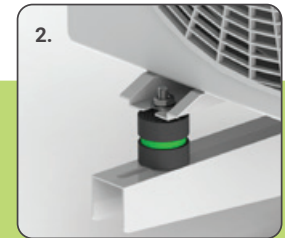
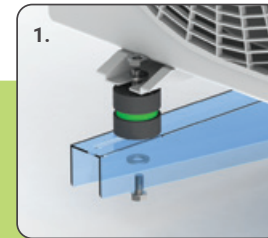

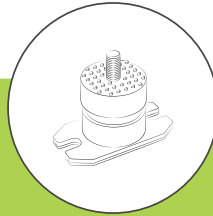

PNOCE4040V series

DAMPER WITH CONTROLLED DEFLECTION

PATENTED elastomeric *NOCE* series damper, designed with an elastic element defined as a connector which, when used between two containers, creates the condition to obtain anti-vibration devices with controlled deflection. This design prevents the vibration damper's deformation under load while insuring the perfect machine's insulation.

Steel base plate with 2 cavities for anchoring the mount to the ground. The surface of the plates has slip-proof, flexible embossing which allow the charged anti-vibration feet to stand by friction and at the same time reduce the transmission of noise.

KIT CONTENTS

- 4 PNOCE4040V feet
- 4 M8 nuts
- 4 M8 washers
- Allen key and Installation guide

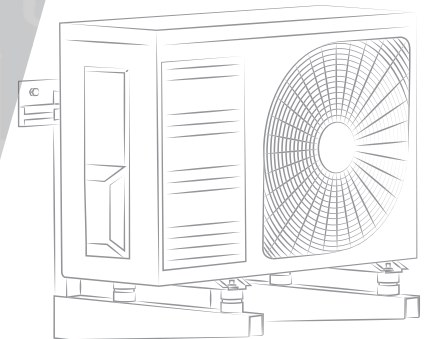
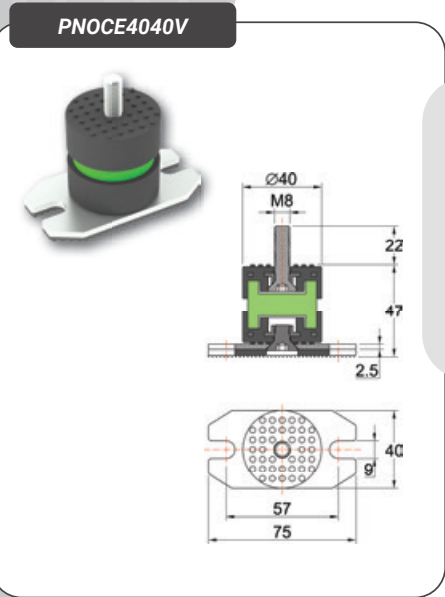

max.
100 Kgs



CBPNOCE4040V22M08L

max.
200 Kgs



CBPNOCE4040V22M08W

max.
350 Kgs



CBPNOCE4040V22M08M

max.
450 Kgs



CBPNOCE4040V22M08H

GROUND ANCHORING



INSTALLATION INSTRUCTIONS

1. Screw the plates to the bases of the anti-vibration feet with the screws and the allen wrench supplied.
2. Place the feet in correspondence of the anchoring holes.
3. Fix the feet to the machine and to the bracket using screws, nuts and washers depending on your necessity.

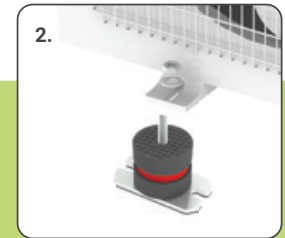
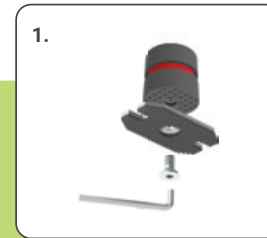

SEG9525 series

ELASTOMERIC DAMPER

Damper in THERMOPLASTIC ELASTOMER which has a high resistance to tearing, atmospheric aging, ozone, detergents, UV rays and also resists to temperatures from -45°C to +110°C.

The base has slip-proof flexible embossing which allow the charged anti-vibration feet to stand by friction and at the same time reduce the transmission of noise. The base has 2 slotted holes for anchoring to the ground.

KIT CONTENTS

- 4 SEG9525 feet
- 4 M8 washers (available also in M10)
- 4 M8 TE screw (available also in M10)
- Installation guide

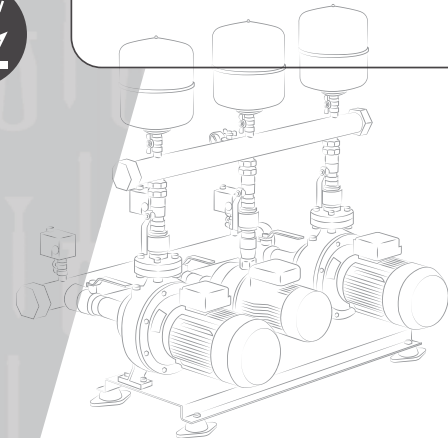
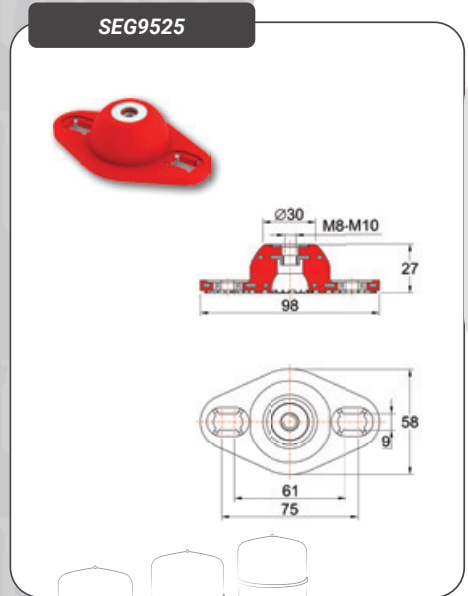
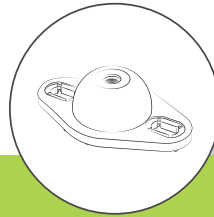



GROUND ANCHORING

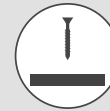

INSTALLATION INSTRUCTIONS

1. Place the feet in correspondence of the anchoring holes.
2. Fix the feet to the machine using screw and washers.
3. Anti-vibration feet installed correctly.

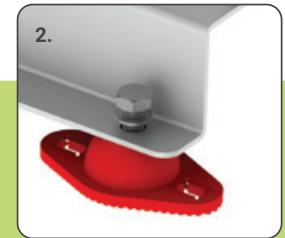

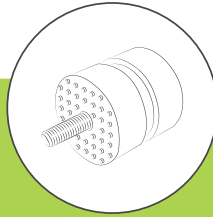

NOCE6050 series

DAMPER WITH CONTROLLED DEFLECTION

PATENTED elastomeric NOCE series damper, designed with an elastic element defined as a connector which, when used between two containers, creates the condition to obtain anti-vibration devices with controlled deflection. This design prevents the vibration damper's deformation under load while insuring the perfect machine's insulation.



AVAILABLE VERSIONS

Available in the following versions: nut-nut (NOCE6050DD), screw-nut (NOCE6050VD) or screw-screw (NOCE6050VV) depending on the anchoring needs.

KIT CONTENTS

- 4 NOCE6050 feet
- M10 nuts (available also in M8/M12)
- M10 washers (available also in M8/M12)
- M10 TE screws (available also in M8/M12)
- Installation guide

NOCE6050DD

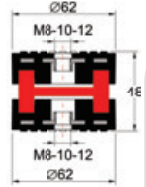
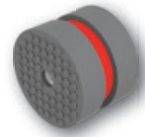

SCREWS: 8 M10 washers and 8 M10 TE screws

NOCE6050VD

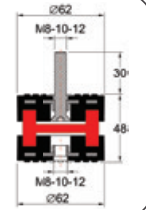
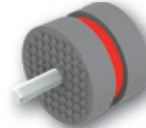

SCREWS: 4 M10 nuts, 8 M10 washers and 4 M10 TE screws

NOCE6050VV

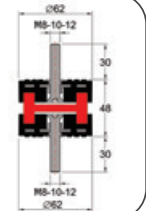
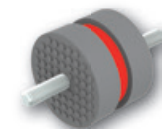

SCREWS: 4 M10 nuts and 8 M10 washers

max.
280 Kgs



CBNOCEVD6050V30M10L

max.
360 Kgs



CBNOCEVD6050V30M10W

max.
640 Kgs



CBNOCEVD6050V30M10M

max.
1000 Kgs



CBNOCEVD6050V30M10H

**ON WALL BRACKET
ON GROUND BASE**



INSTALLATION INSTRUCTIONS

1. Place the feet in correspondence of the anchoring holes.
2. Fix the feet to the machine and to the bracket using screws, nuts and washers depending on your necessity.
3. Anti-vibration feet installed correctly.

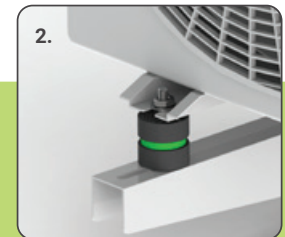
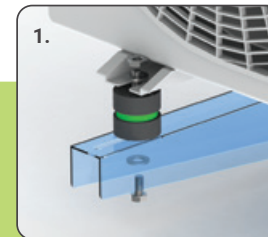

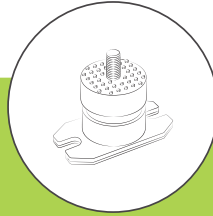

PNOCE6050V series

DAMPER WITH CONTROLLED DEFLECTION

PATENTED elastomeric NOCE series damper, designed with an elastic element defined as a connector which, when used between two containers, creates the condition to obtain anti-vibration devices with controlled deflection. This design prevents the vibration damper's deformation under load while insuring the perfect machine's insulation.

Steel base plate with 2 cavities for anchoring the mount to the ground. The surface of the plates has slip-proof, flexible embossing which allow the charged anti-vibration feet to stand by friction and at the same time reduce the transmission of noise.

KIT CONTENTS

- 4 PNOCE6050V feet
- 4 M10 nuts (available also in M8/M12)
- 4 M10 washers (available also in M8/M12)
- Allen key and Installation guide

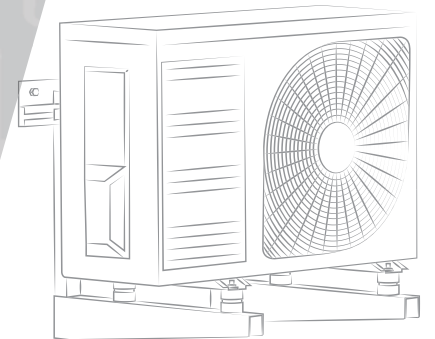
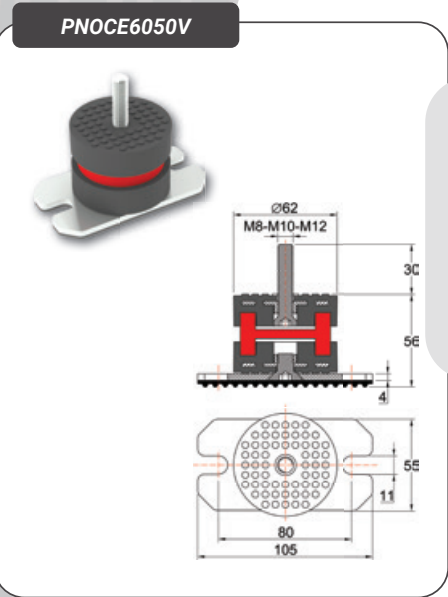

max.
280 Kgs



CBPNOCE6050V22M10L

max.
360 Kgs



CBPNOCE6050V22M10W

max.
640 Kgs



CBPNOCE6050V22M10M

max.
1000 Kgs



CBPNOCE6050V22M10H

GROUND ANCHORING



INSTALLATION INSTRUCTIONS

1. Screw the plates to the bases of the anti-vibration feet with the screws and the allen wrench supplied.
2. Place the feet in correspondence of the anchoring holes.
3. Fix the feet to the machine and to the bracket using screws, nuts and washers depending on your necessity.

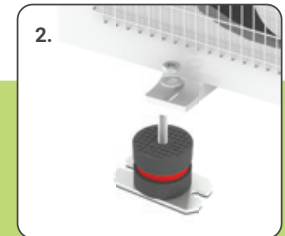

MCF series

ELASTOMERIC DAMPER

Damper in THERMOPLASTIC ELASTOMER which has a high resistance to tearing, atmospheric aging, ozone, detergents, UV rays and also resists to temperatures from -45°C to +110°C.

The surface of the plate and the base has slip-proof, flexible embossing which allow the charged anti-vibration feet to stand by friction and at the same time reduce the transmission of noise.

KIT CONTENTS

- 4 MCF feet
- 4 M10 nuts (available also in M8/M12)
- 4 M10 washers (available also in M8/M12)
- Installation guide

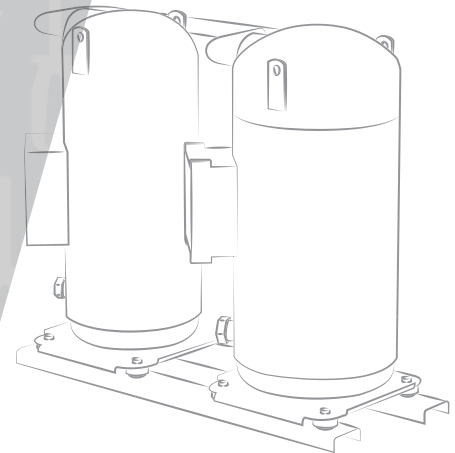
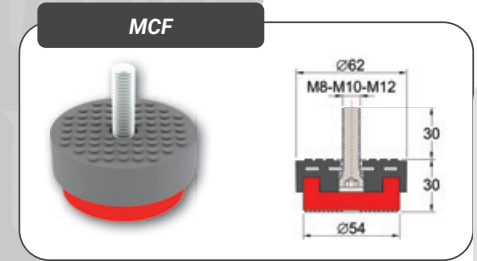
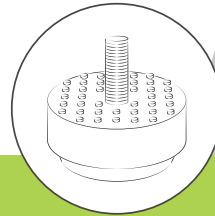



**ON THE
GROUND**



INSTALLATION INSTRUCTIONS

1. Place the feet in correspondence of the anchoring holes.
2. Fix the feet to the machine using nuts and washers.
3. Anti-vibration feet installed correctly.

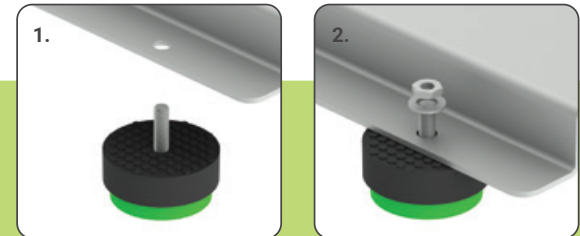

MNaZc - p. 3

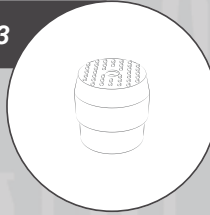

NOCE4040 - p. 13

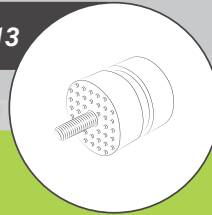

COUNTER DISPLAY

Practical cardboard counter display with metal hooks.

Dimensions: 450x222x500 mm

Can fit 24 assorted kits of the *MNaZc* and the *NOCE4040* series to isolate machines up to 120 Kgs.

Blister kits are supplied with fixation screws and installation instructions.

Check out our user friendly guide to choose the most appropriate kit for your installation needs on page 2.

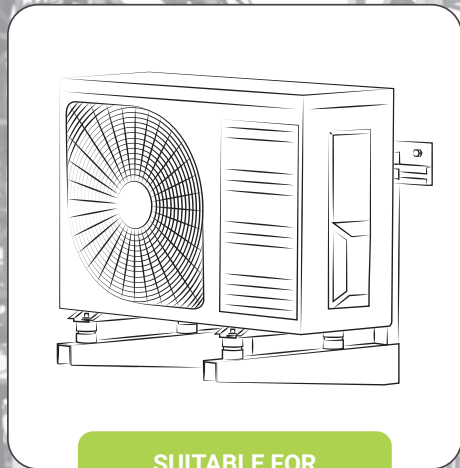

SUITABLE FOR
INSULATING MACHINES
WITH WEIGHT UP TO
120 KG



450x222x500 mm

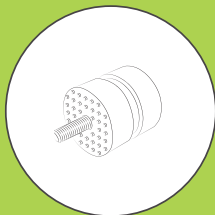

DISTRIBUTED BY

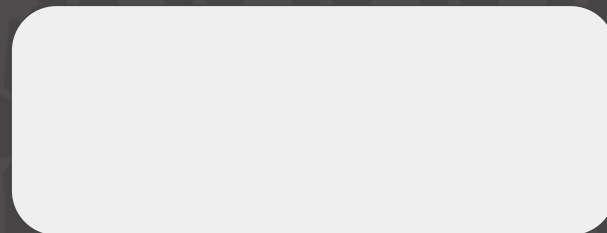

www.solecosrl.com - soleco@solecosrl.com

via Masaccio 12, 20096 Pioltello (Mi) - Italy tel +39 02 92 44 311 - fax +39 02 73 96 50 50

cod.fisc. e p.IVA 01349290153 - reg. impr. MI 148283 M.9711244 - R.E.A. MI 835036